

Assembly instructions

PO220 PopUp 2x3 curved double sided



The contents of the package:

- A. PopUp graphic: 6 panels
- B. Metal bars and textile bag: 18 pieces
- C. PopUp frame: 1 piece

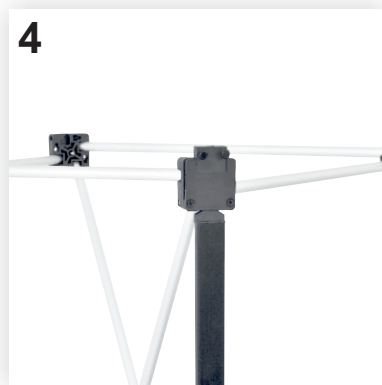
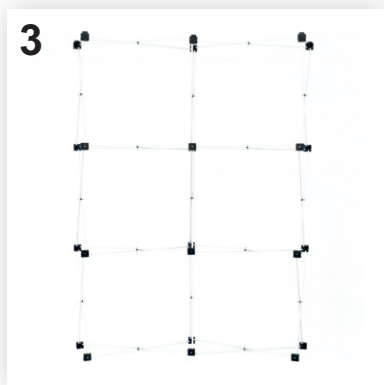
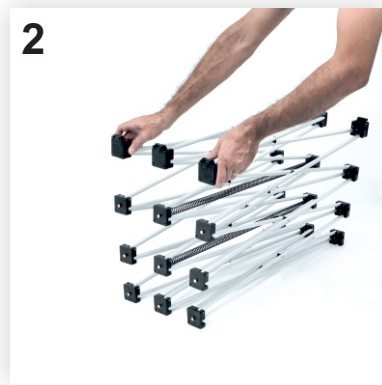

1. Place the PopUp frame (C) on the floor ensuring the row of the hanging cloves is at the top of the frame, as in the picture.

2. Stretch the frame (C) to size by pulling up two of the black pieces of plastic. The structure (C) will extend both vertically and horizontally.

3. After expanding the structure (C), it will look like in the picture.

4. Add the metal bars (B) from top to bottom starting from the black plastic nodes with cloves: insert the tip of the metal bar (B) into the slot under the black node, as in the picture.

5. The square at the bottom of the metal bar (B) will be fixed into position by sliding it from right to left until it overlaps the black plastic node, like in the detailed image.

6. Continue, in the same way, attaching all the metal bars in a vertical line until you get six vertical lines of three bars each: three lines in the front and three lines in the sideback.

Now the PopUp frame (C) is assembled.

The pictures are for presentation only; your product can be slightly different!

Assembly instructions

PO220 PopUp 2x3 curved double sided

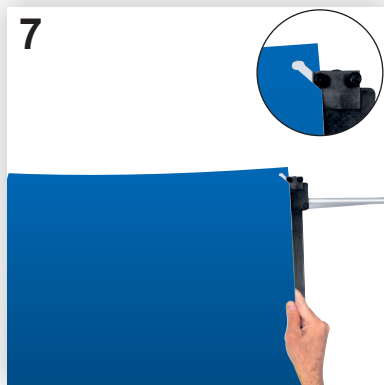

7. Now attach the PopUp graphic (A). The graphic panels (A) are numbered to facilitate their positioning left-to-right on the structure (C). Hang the panels in the cloves at the top of the structure (C) as in the picture. It is recommended to attach the graphic panels starting with the front middle panels number 2 and 3 then continue with the back panels 5 and 6.

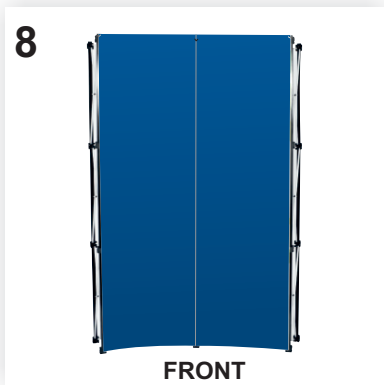

8. Unroll each graphic panel to its full length and attach it to the metal bars (B). The edge of each panel will be positioned on the middle of the metal bar, the other half remaining free for attaching the next panel. In the curved systems, the panels will have a small inward curvature at the front (see picture 8) and a small outward curvature at the back of the structure (see picture 9).

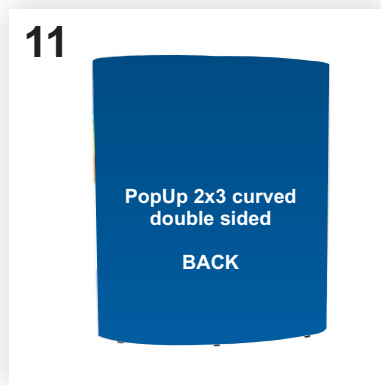
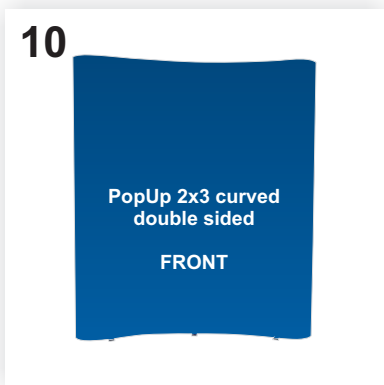
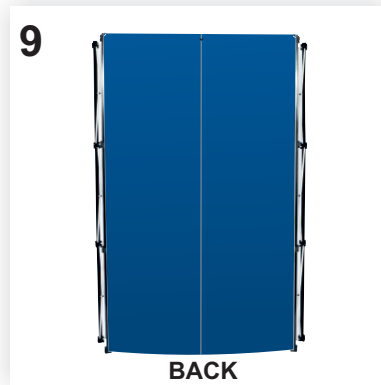

9. After attaching the front panels, you can fix into position the side panels: 1 and 4. They bend in the shape of a semi-cylinder and hang with one edge in front and the other behind the structure (C) to form the side of the PopUp.